

# The Murphy eGuard System Controller Installation and Operations Manual



## Table of Contents

<b>Contents</b>	<b>page #</b>
<b>Warnings and Limited Warranty</b> .....	3
<b>eGuard Keypad Basics</b> .....	4-5
<b>The eGuard Screens</b> .....	6-8
Meter Screens.....	6
Operational Screens.....	6-8
Access Security Screens.....	8
Setting Access Security .....	8
<b>Editing Parameters</b> .....	9
<b>Parameter Table</b> .....	10-23
Operation Parameters.....	10-11
Communication Parameters.....	12
Miscellaneous Parameters.....	12-13
Engine Parameters.....	13-15
System Control Parameters.....	16-19
System Control Parameter Diagrams.....	17
Active Parameters for Start/Stop Type LEVEL.....	18
Active Parameters for Start/Stop Type FLOW.....	18
Active Parameters for Start/Stop Type PRESSURE.....	19
Digital Input Parameters.....	20
Relay Parameters.....	21-22
Analog Input Parameters.....	23
Clock Start/Stop Parameters.....	23
<b>Sequence of Operation Flow Charts</b> .....	24-26
Powerup, Stop & Error Stop State Diagram .....	24
Auto Start/Stop Cycle State Diagram .....	25
Manual Start/Stop State Diagram .....	26
<b>Finetuning</b> .....	27
<b>Calibration of Senders for Analog Inputs</b> .....	27-28
<b>Installation and Connections</b> .....	29-33
Standard Components.....	29
Physical Specifications.....	29
Electrical Specifications.....	29
eGuard Typical Components.....	29
Mechanical Installation and Mounting.....	30
Typical Mounting Schematic.....	30
eGuard Cut-out Template.....	31
eGuard Electrical Installation.....	32
Electrical Installation.....	32-34
Commercially Available Connectors.....	34
Connector Part Number.....	34

MURPHY, the Murphy logo, and eGuard are registered and/or common law trademarks of Murphy Industries, Inc. This document, including textual matter and illustrations, is copyright protected by Murphy Industries, Inc., with all rights reserved. © 2004 Murphy Industries, Inc.

Modbus® and other third party product or trade names referenced herein are the property of their respective owners and are used for identification purposes only.



# WARNING!



FW MURPHY has made efforts to ensure the reliability of the eGuard System and to recommend safe usage practices in system applications. Please note that in any application, operation and controller failures can occur. These failures may result in full control outputs or other outputs which may cause damage to or unsafe conditions in the equipment or process connected to the eGuard system.

Good engineering practices, electrical codes, and insurance regulations require that you use independent external protective devices to prevent potentially dangerous or unsafe conditions. Assume that the eGuard system can fail with outputs full on, outputs full off, or that other unexpected conditions can occur.

**Please read the following information before installing the eGuard.**

This installation information is intended for all eGuard Series models. A visual inspection of this product before installation for any damage during shipping is recommended.

Disconnect all power and be sure machine is inoperative before beginning installation.

Installation is to be done only by qualified technician.

Observe all Warnings and Cautions at each section in these instructions.

Please contact FW MURPHY immediately if you have any questions.

## Warranty

A limited warranty on materials and workmanship is given with this FW Murphy product.

A copy of the warranty may be viewed or printed by going to [www.fwmurphy.com/support/warranty.htm](http://www.fwmurphy.com/support/warranty.htm)

## The Murphy eGuard System Controller

Welcome to the eGuard System Controller. This state-of-the-art high-performance digital controller is designed for easy installation, setup, and day-to-day operation.

Using high-speed microprocessors and featuring a large, easy-to-read display, the flash-based eGuard can be configured simply and quickly to match a vast set of specific applications and conditions.

### eGuard Keypad Basics

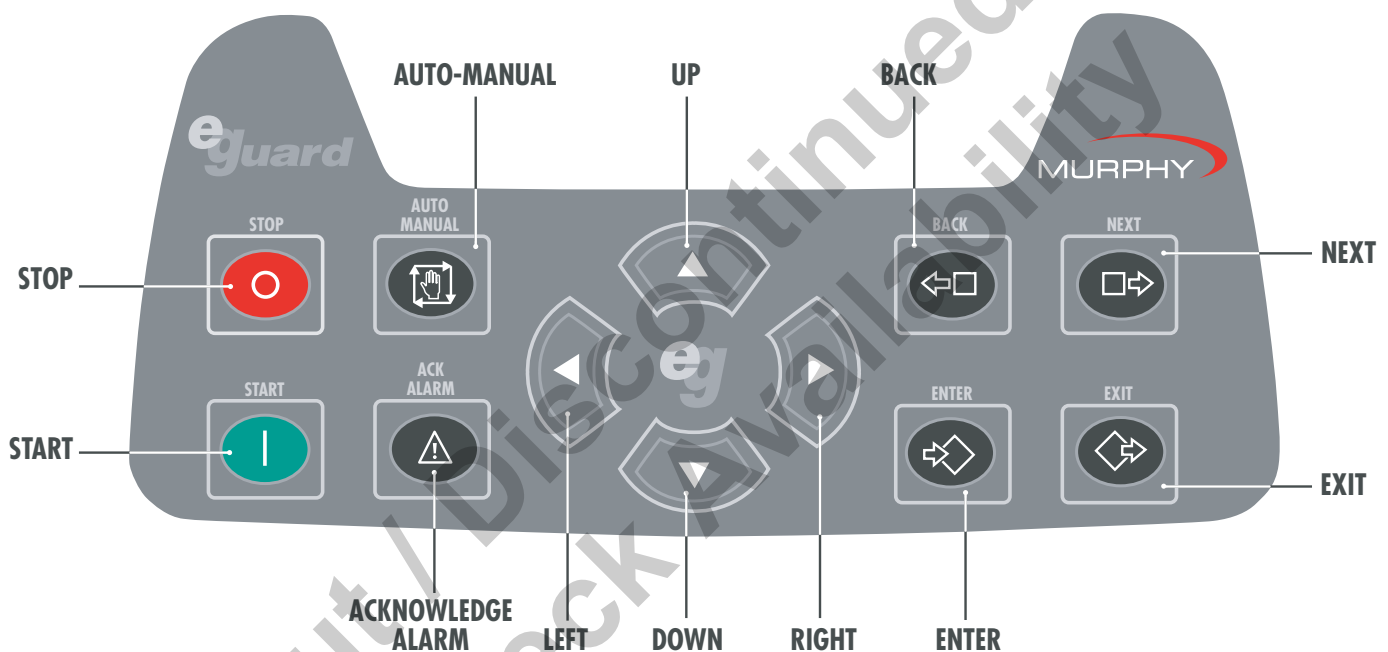

Completely sealed from the front, and with no mechanical switches to wear or stick, the eGuard keypad operates reliably in extreme temperatures and when ice, snow, mud, grease and other conditions require the operator to wear gloves.

The eGuard keypad is a touch-sensing system. The keys do not click or depress. When you press a key, you will hear a beep. This sound confirms that your command has been entered successfully. (You also have the option of turning the sound off. The screen will provide visual confirmation.) For best results, touch the key with the flat portion of your finger, rather than the tip (see detail at right). Key sensitivity can be adjusted. See Operations Parameters for more information.



**SUGGESTED FINGER POSITION SHOWN**

## **eGuard Keypad Basics (continued)**

---



### **Start**

- In manual mode, press the Start key to start the engine.
  - In automatic mode, an error message will tell you to revert to manual mode. Return to manual mode and press the Start key again.
- 



### **Stop**

Press the Stop key to stop the engine. If you are in automatic mode, the system will return you to manual mode. You may then return to automatic mode to reactivate autostart.

---



### **Auto/Manual**

Press the Auto/Manual key to choose manual (local) or automatic (monitored signal) mode.

---



### **Acknowledge**

- Press the Acknowledge key to clear active alarms that do not cause a shutdown (If conditions clear and then recur, or if additional warnings occur, the common alarm output will reactivate).
  - For Error/Stop conditions, press this key three times to reset and clear.
- 

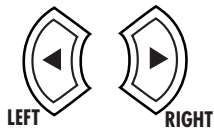

### **Left/Right Arrows**

- Use to reach specific Parameter Screens.
  - Press both simultaneously for Access Security Screen. (See page 8 for more information on Access Security.)
- 



### **Up/Down Arrows**

- Use to scroll through Meter Screens.
  - Used to scroll through specific Parameters within a Menu and to adjust settings for specific Parameters (after pressing Enter).
- 



### **Next**

- Use to move forward through Operational Screens.
- 



### **Back**

- Use to move backward through Operational Screens.
- 



### **Enter**

Press Enter in program mode to accept Parameter adjustments. Selected settings will display on the screen.

---





### **Exit**

Press Exit in program mode to complete Parameter editing and return to the Meter screen in use.

## The eGuard Screens.

The eGuard System Controller is designed for ease of use and depth of functionality. Screen displays provide both detailed information and clear cues to lead you through operational sequences.

- To move throughout the screens below use the Back and Next keys. 
- To move throughout multiple pages within a screen use the Up and Down keys. 

Typical screens include:

### Meter Screens

The meter screens display information about the engine and engine-driven equipment. Below are examples of the types of information that may be displayed.

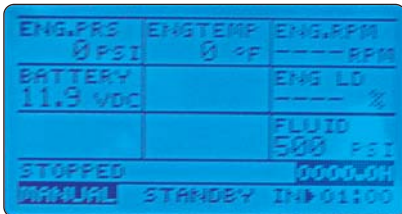

3 x 3 Screen format

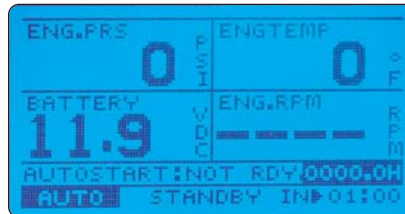

2 x 2 Screen format



1 up Screen format

The Exit key toggles between the most recent meter screen and the Warnings Status Screen. If connected on electronic engine and an engine error occurs, a J1939 screen will be in toggle until the engine error goes away.

### Operational Screens

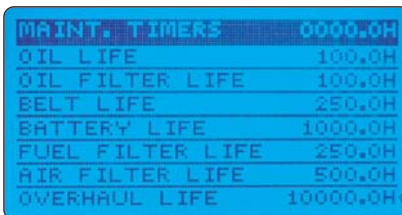

#### Maintenance Timers Screen

Displays current engine hours and all 7 consumable maintenance timers.



#### J1939 Message Screens (electronic engine only)

Displays ECU# (ECM) LAMP status on page 1. Scroll through current warning screens using the Up/Down key. (This screen will not appear when a mechanical engine is used.)



#### Splash Screen

Displays the company logo.

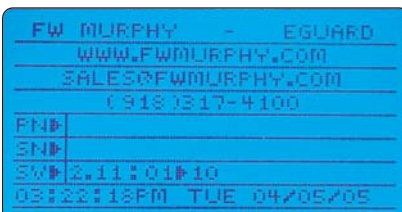

#### Information Screen

Displays service and contact information and software version number.

## The eGuard Screens (continued)

```
SYSTEM SETTINGS
TYP: LEVEL DIR: EMPTY
START= 5FT@HI2000RPM
STOP= 15FT@LO 300RPM
LVL: 18.8FT,SPD: 0000RPM
LOPWARN: 20.0|LOP3H: 15.0
STOPPED 0000.0H
MANUAL STANDBY IN 01:00
```

### System Settings Screen

Displays the status of current autostart, autostop, and control functionality.

```
THROTTLE STATUS
ACTUAL: --- RPM
TARGET: NOT RUNNING
STOPPED 0000.0H
MANUAL STANDBY IN 00:59
```

### Throttle Status Screen

Displays target throttle speed and engine rpm while in operation. Allows manual throttle adjustment when J1939 is enabled.

```
RELAY FUNCTIONS 14/106
8:111: NOT IN AUTO
102: LOW ENGINE TEMP.
4: ECU ENABLE
: FUEL N/C
: AIRDAMPER N/ENERGIZED
: NOT IN STANDBY/AUX DEV.
```

### Active Relay Functions Screen

Displays all currently active eGuard relay functions. Displays relay number if the function is assigned to a valid relay.

```
EVENT HISTORY ▲▼ 1/32
```

### Event History Screen

Displays the last 32 events beginning with the most recent.

```
WARNINGS/STATUS
ECU NOT RESPONDING
ENGINE TEMP. TOO LOW
NS: ECU NOT RESPONDING
STOPPED 0000.0H
MANUAL STANDBY IN 01:00
```

### Warning Status Screen

Displays all current warnings and faults.

```
ENGINE/SYSTEM STATUS
0 PSI 0 °F --- RPM
11.9 VDC 03:25PM --- %
18.8 FT
STOPPED 0000.0H
MANUAL STANDBY IN 01:00
```

### Engine/System Status Screen

Displays up to 15 different meter values on one screen.

## The eGuard Screens *(continued)*

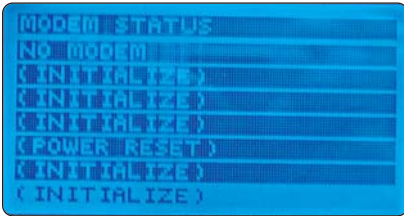

### Modbus Server Screen



**IMPORTANT:** NOT IN STANDARD CONFIGURATION. WILL DISPLAY IF MODBUS MAPPING IS ACTIVE.

Displays a list of modbus device servers connected to the J3 RS485 contacts. Any server (slave) device with a definition appears with its address and function. An unrecognized server device appears as !POSIT! meaning there is something at the address but it is not a recognized function.

## Access Security Screen



The Access Security Screen is the key to all eGuard functions. There are six Access Security levels:

- Level 0:** No operational access. Allows viewing of data screens (through next and back keys), but parameters cannot be viewed or edited.
- Level 1:** Allows manual start and stop, but no parameters can be viewed.
- Levels 2 – 5:** Allows for viewing of all parameters and editing of some parameters. (Note: See Parameter Table in appendix for minimum required security level for all parameters.)
- Level 6:** For administrative use. **Note:** some changes in level 6 cannot be reversed.

**NOTE:** Factory default set to level 1.

### Setting Access Security

Begin with the eGuard in **Manual** mode.



Press the Left and Right arrows simultaneously to go to the Edit Password Screen.

- You will see four columns. A 4-character security code is required.
- The cursor display opens in column 1.



Press the Up and Down Arrows to change the settings in each column.



Press the Right and Left Arrows to move the cursor forward and back.

- Enter the correct password.

Press Enter.





- Verify that the Access Security Level you entered is displayed at the bottom of the screen.



Press Exit to begin editing parameters.





## Editing Parameters:

Follow directions for Access Security (see page 8 for more information).

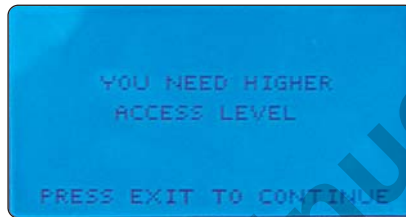
-  1. Use Left and Right arrows to navigate through the different parameter menus (i.e. Operation Parameters, Communications Parameters, etc.)
-  2. Use Up and Down arrows within a menu to access a specific parameter.
-  3. Press Enter to view range or options for that parameter.

**Note:** If your security level is too low to edit a chosen parameter, a screen will alert you and take you back to the parameter screen in use.



-  4. Use the Up and Down keys to adjust the setting.
-  5. Press Enter to lock in the appropriate setting. (Note: The screen will stop blinking to indicate the change is registered.)
-  6. Press the Up and Down keys to go to another parameter within that menu
-  7. When finished, press the Exit key to access the Meter Screen.

Parameter	Description	Range/Options	Minimum Required Security Level	Factory Default Setting	Applications Requiring This Setting	Customer Notes
<b>OPERATION PARAMETERS</b>						
Access Security	Allows input of 4-character security code.	0-6		1		
Language	Allows selection of display language.	English, Spanish	2	English		
Driven Equipment Type	Allows selection of type of equipment being driven by eGuard.	Engine + Driven Equipment, Engine Only	5	Engine + Driven Equipment	Electronic Mechanical	
Key Sensitivity	Sets keypad touch sensitivity.	Normal, High	2	Normal		
Default Screen	With system active, this screen appears first.	Event History, Warnings/Status, Engine/System Status, Meters, System Settings	3			
Lamp Test	NFPA requirement; confirms that LED display is working.		3			
LCD Backlight	Turns the display backlight off in normal conditions. In error conditions, activates common visual alarms.	Enabled, Disabled	2	Enabled		
eGuard Beeper	Enabled: sounds with every key press and error event. Disabled: silences keypad beeper response, but sounds to report errors.	Enabled, Disabled	2	Enabled		
Pressure Units	Selects units for pressure.	PSI, KPA, BAR	2	PSI		
Temperature Units	Selects units for temperature display.	F, C	2	F		
Date Display Format	Date format.	MM/DD/YY, DD/MM/YY	2	MM/DD/YY		
Event Type Record	Selects which events to capture and store in event history.	All Event Types, Shutdowns Only	3	All Event Types		
Clear Event History	Clears shutdown history when enter key is pressed.	Clear History (Enter)	3			
Standby Mode Timer	Allows system to switch to low-power Standby Mode. When set time expires, LCD screen shows text message, and the blue LCD Backlight turns off. Any key press or remote call brings unit out of Standby. When off is selected, the unit never goes into Standby. Adjustable in: 30-sec. increments.	Off, 1:00 - 59:30	3	01:00		

Parameter	Description	Range/Options	Minimum Required Security Level	Factory Default Setting	Applications Requiring This Setting	Customer Notes
Run to Destruct	Can enable if board trace has been cut. When enabled, system will only sound alarms for errors but will not shut down. To prevent equipment or load destruction, both a menu selection and a physical trace on the board must be cut to activate this feature. (See _____ for more information on cutting board trace.) Installation & Connection Section	Disabled, Enabled		Disabled		
Edit Time/Date	Sets local time and date.	(Arrow keys allow adjustment of time, day of week and date)	2	Central Standard Time		
Input/Output Test	Allows user to manually force outputs on and off and to monitor inputs. Caution: Adjustments here can override relay outputs. Prior to adjusting, see Troubleshooting section.)	N/A	3	N/A		
Reset Configuration	Purges any configuration changes made by user and resets the controller to last-known factory or PC configuration.	Are you sure? (Yes or No)	5	Are you sure? (Yes or No)		
Operation Mode	Sets controller to specific operating mode. (Note: In Manual/Auto NFPA, the screen flashes/beeper sounds when eGuard changes modes.)	Manual/Auto No Warning, Manual Mode Only, Manual/Auto NFPA	5	Manual/Auto No Warning		
Duplicate Senders	Allows user to select duplicate senders for one given parameter, e.g. oil pressure, engine temperature. (Note: J1939 always regarded as primary source.)	Not Allowed, Allowed	3	Not Allowed		
Repeater 1	Sets mode for remote annunciator/repeater. Mimic: operates and controls the eGuard. Annunciator: displays but does not operate the eGuard.	Mimic, Annunciator	3	Mimic		
Repeater 2	Sets mode for remote annunciator/repeater. Mimic: operates and controls the eGuard. Annunciator: displays but does not operate the eGuard.	Mimic, Annunciator	3	Mimic		
Winter/Summer Setpoint	Enables Preheat mode if the engine temperature falls below the set value.	0 – 255 F	3	255 F		
Channel 1 Open Sender SD	Allows user to override open sender detection method.	Off, Immediate, After 1 - 90 min. bypass	3	Immediate		
Channel 2 Open Sender SD	Allows user to override open sender detection method.	Off, Immediate, After 1 - 90 min. bypass	3	Immediate		
Channel 3 Open Sender SD	Allows user to override open sender detection method.	Off, Immediate, After 1 - 90 min. bypass	3	Immediate		
Channel 4 Open Sender SD	Allows user to override open sender detection method.	Off, Immediate, After 1 - 90 min. bypass	3	Immediate		

Parameter	Description	Range/Options	Minimum Required Security Level	Factory Default Setting	Applications Requiring This Setting	Customer Notes
<b>COMMUNICATION PARAMETERS</b>						
J-2 Protocol Type	Allows selection of the protocol type for the single comm. port on the I/O board.	RS232 eGuard config, RS485 Modbus Server	3	RS232 eGuard config		
Modbus Server Address	Address of eGuard when acting as server.	0 – 247	3	247		
RS485 Server Protocol	Allows selection of appropriate settings for Modbus setup.	10 bits (N-8-1), 11 bits (N-8-2)	3	10 bits (N-8-1)		
RS485 Server Baud Rate	Allows selection of appropriate settings for Modbus setup.	9600-19200	3	38400		
RS485 Client Protocol	Allows selection of appropriate settings for Modbus setup.	10 bits (N-8-1), 11 bits (N-8-2)	3	10 bits (N-8-1)		
RS485 Client Baud Rate	Allows selection of appropriate settings for Modbus setup.	9600 – 19200	3	38400		
Modem Connection	Selects whether modem is present.	Disabled, Enabled	3	Disabled		
RS232 Baud Rate	Allows selection of appropriate baud rate for RS232 communications.	9600, 19200, 57600, 115200	3	38400		
<b>MISCELLANEOUS PARAMETERS</b>						
Engine & ECU Type	Sets which ECU communication interface will be used to provide engine parameters. (Note: Select None for mechanical engines. Select J1939 + J1939 hours for electronic engines that broadcast engine hours. Select J1939 + eGuard engine hours for electronic engines that do not broadcast engine hours.)	None, J1939 + eGuard engine hours, J1939 + J1939 hours	3	J1939 + eGuard Engine hours	Electronic Mechanical	
Crank Cut Types	Sets Primary and Secondary Crank Termination indicators.	1:MPU 2:J1939 1:J1939 2:None 1:J1939 2:Dig. Input 1:J1939 2:MPU 1:MPU 2:None 1:MPU 2:Dig. Input	3	1:J1939 2:None		
ECU Address Claim	Select Single ECU for most applications. Select Multiple ECUs for engines with more than one ECU. None required may be required to be used on singled engine ECUs in some instances. (See _____ for more information.)	None required, Single ECU, Multiple ECUs	3	Single ECU	Electronic	
Engine Manufacturer	Sets engine manufacturer (Note: Required to be set correctly when using an Electronic Engine.)	Caterpillar, Cummins, Deere, Detroit, Deutz, Ford, GM, Hatz, Isuzu, Kubota, Lister-Petter, Mercedes, Perkins, Volvo, Other	3	Other	Electronic	
J1939 Crank Cut Count	Allows adjustment for the J1939 rpm PGN filter.	5 - 60	3	15		

Parameter	Description	Range/Options	Minimum Required Security Level	Factory Default Setting	Applications Requiring This Setting	Customer Notes
Fuel Level Source	Tells eGuard where to look for fuel level data.	None, Analog Input	3	None		
Oil Life	Sets service interval timer for maintenance reminder.	Off – 1000 hours	2	100 hours		
Oil Filter Life	Sets service interval timer for maintenance reminder.	Off – 1000 hours	2	100 hours		
Belt Life	Sets service interval timer for maintenance reminder.	Off – 1000 hours	2	250 hours		
Battery Life	Sets service interval timer for maintenance reminder.	Off – 1000 hours	2	1000 hours		
Fuel Filter Life	Sets service interval timer for maintenance reminder.	Off – 1000 hours	2	250 hours		
Air Filter Life	Sets service interval timer for maintenance reminder.	Off – 1000 hours	2	500 hours		
Overhaul Life	Sets service interval timer for maintenance reminder.	Off – 100000 (Format 10,000 x 10 hrs)	2	1000 x 10 hrs		
<b>ENGINE PARAMETERS</b>						
Pre-Autostart Delay	Sets the amount of time to require the automatic signal to be preset before starting engine.	0- 300	3	2 seconds		
Preheat Type	Selects preheat type	None, Warmup, Bypass Timer, Crank Through, Precrank	3	None		
Pre-lube Time	Amount of time a pre-lube output stays on prior to allowing a start.	0 – 99 sec.	3	0 sec.		
Pre-heat time	Amount of time engine is pre-heated prior to cranking.	0 – 99 sec.	3	0 sec.		
Purge Crank Time	Sets amount of time purge crank state is active without fuel being present.	0 – 99 sec.	3	0 sec.		
Crank Time	In automatic crank cycle, the longest time an engine cranking motor can be energized.	3 – 99 sec.	3	15 sec.		
Crank Rest Time	In automatic crank cycle, time the engine cranking motor is off between crank attempts.	3 – 99 sec.	3	15 sec.		
Start Attempts	Maximum number of engine start attempts before displaying a fault.	1 – 15 cycles	3	3 cycles		
Start-up Bypass Time	Delay used to temporarily disable the low engine oil pressure, high engine temperature and various other shut-down faults until the engine can come to a running condition.	3 – 99 sec	3	10 sec		
Warm-Up at Idle Delay	Time engine runs at idle speed before increased speed is allowed.	0 sec. – 60 min. (Format 0:00:00)	3	15 sec.		

Parameter	Description	Range/Options	Minimum Required Security Level	Factory Default Setting	Applications Requiring This Setting	Customer Notes
Line Fill Timer	Amount of time controller spends at speed set in Engine Line Fill Speed before proceeding to the programmed operating speed. (Note: Coordinate with Engine Line Fill Speed setting.)	0 sec. – 60 min. (Format 0:00:00)	3	0 sec.		
Engine Cooldown	(Note: Only operational in Auto mode.) Upon removal of Remote Call to Run, amount of time engine will run prior to shutting off. (Note: Cooldown will return engine to idel.)	0 sec. – 300 min. (Format 0:00:00)	3	30 sec.		
Post-lube Time	Sets the amount of time that post-lube state is active.	0- 99 sec.	3	0 sec.		
Flywheel Tooth Count	Sets the number of teeth (pulses) that occur during one revolution of engine.	0 – 450 teeth	3	0 teeth	Mechanical	
Crank Termination RPM	Engine RPM at with the crank output will de-energize.	0 – 6000 RPM	3	600 RPM		
Engine Idle Speed	Low speed idle set-point.	0 – 6000 RPM	3	900 RPM		
Engine Line Fill Speed	Engine remains at this speed for the length of time set in the Line Fill Timer. (Note: Coordinate with Line Fill Timer setting.)	0 – 6000 RPM	3	900 RPM		
Engine Run Speed	Allows user to define maximum RPM setting. (Note: Operational in Manual and Auto modes.)	0 – 6000 RPM	3	2000 RPM		
Engine Overspeed RPM	Speed at which a shutdown will occur.	0 – 6000 RPM	3	2150 RPM		
Clutch Release RPM	When engine speed rises above this set-point, the At Load clutch relay will close to load the set. When the RPM falls below this set-point, the clutch will open to unload the set.	0 – 6000 RPM	3	1200 RPM		
Throttle Type	Selects throttle type.	J1939 Speed Control, Relay Pulse inc/dec information.)	3	J1939 Speed Control	Mechanical Electronic	
Throttle Increase Pulse	(Note: Operational in Auto mode only.) When Throttle Type: Relay Pulse Inc/Dec is selected, this is the amount of time the throttle increase relay stays energized. (Note: See Troubleshooting section for more	.05 – 2.5 sec.	3	1.00 sec		
Throttle Decrease Pulse	(Note: Operational in Auto mode only.) When Throttle Type: Relay Pulse Inc/Dec is selected, this is the amount of time the throttle decrease relay stays energized. (Note: See Troubleshooting section for more information.)	.05 – 2.5 sec.	3	1.00 sec		
Throttle Feedback Delay	(Note: Operational in Auto mode only.) When Throttle Type: Relay Pulse Inc/Dec is selected, this is the amount of time the throttle relay stays de-energized. (Note: See Troubleshooting section for more information.)	.05 – 2.5 sec.	3	1.00 sec		

Parameter	Description	Range/Options	Minimum Required Security Level	Factory Default Setting	Applications Requiring This Setting	Customer Notes
Throttle Deadband RPM	(Note: Operational in Auto mode only.) This setting defines the range of RPM above or below the current target speed where no throttle changes occur. (Note: See Troubleshooting section for more information.)	5 – 250 RPM	3	50 RPM		
Throttle Ramp Time	(Note: Operational in Auto mode only.) Time to go from minimum to maximum RPM. (Note: See Troubleshooting section for more information.)	0 - 255 sec.	3	15 sec.		
Throttle Sensitivity	(Note: Operational in Auto mode only.) This adjusts how fast/how much the throttle responds to a throttle increase or decrease. Lower numbers result in a slower response, higher numbers result in faster response. (Note: See Troubleshooting section for more information.)	4 - 200	3	8		
J1939 Throttle Rate	Fine-tunes the throttle response. (Note: Measured in RPM/sec.)	50 – 250 RPM	3	100 RPM		
LOP Warning Offset PSI (See <b>A</b> on graph below)	This setting defines the Low Oil Pressure (LOP) PSI above the target PSI at which a warning will occur.	0 – 120 PSI	3	5 PSI		
LOP at Low Speed PSI (See <b>B</b> on graph below)	This setting defines the Low Oil Pressure (LOP) PSI at Low Speed LOP RPM at which a shutdown will occur. (Coordinate with Low Speed LOP RPM setting.)	0 – 120 PSI	3	15 PSI		
LOP at High Speed PSI (See <b>C</b> on graph below)	This setting defines the Low Oil Pressure (LOP) PSI at High Speed LOP RPM at which a shutdown will occur. (Coordinate with High Speed LOP RPM setting.)	0 – 120 PSI	3	15 PSI		
Low Speed LOP RPM (See <b>D</b> on graph below)	This setting defines the RPM where LOP at Low Speed PSI will be measured. (Coordinate with LOP at Low Speed PSI setting.)	0 – 6000 RPM	3	600 RPM		
High Speed LOP RPM (See <b>E</b> on graph below)	This setting defines the RPM where LOP at High Speed PSI will be measured. (Coordinate with LOP at Low Speed PSI setting.)	0 – 6000 RPM	3	600 RPM		

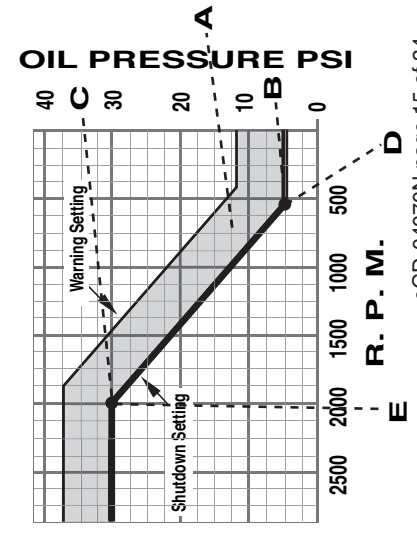

Parameter	Description	Range/Options	Minimum Required Security Level	Factory Default Setting	Applications Requiring This Setting	Customer Notes
High Oil Temp Warning	This setting defines the high oil temperature above the target temperature at which a shutdown warning will occur.	160 - 350 F	3	245 F		
High Oil Temp Shutdown	This setting defines the high oil temperature at which a shutdown will occur.	160 - 350 F	3	250 F		
Low Engine Temp Warning	This setting defines the low engine temperature below the target temperature at which a warning will occur.	0 - 100 F	3	25 F		
High Engine Temp Warning	This setting defines the high engine temperature above the target temperature at which a warning will occur.	160 - 320 F	3	230 F		
High Engine Temp Shutdown	This setting defines the high engine temperature above the target temperature at which a shutdown will occur.	160 - 320 F	3	235 F		
Battery Weak Warning	The DC voltage set-point at which an alarm will occur. (Note: Checked during cranking only.)	0 - 25.5 VDC	3	1.0 VDC		
Battery Low Warning VDC	The DC voltage set-point at which an alarm will occur. (Note: Ignored during cranking.)	0 - 25.5 VDC	3	10.0 VDC		
Battery High Warning VDC	Battery voltage equal to or greater than this indicates overcharging of battery. (Note: Ignored during cranking.)	12 - 40 VDC	3	16.0 VDC		
Fuel Low Warning	This setting defines the low fuel level at which a warning will occur.	0 - 100%	3	35%		
Fuel Low Shutdown	This setting defines the low fuel level at which a shutdown will occur.	0 - 100%	3	5%		
Energize to Stop Timer	Energize to stop timer - In systems requiring an "Energize to stop" fuel solenoid control, this is the time that the solenoid will stay energized to shut the system down.	0 - 120 sec.	3	0 sec.		
High Oil Pressure Shutdown PSI	This setting defines the High Oil Pressure PSI at which a shutdown will occur.	Disabled, 1 - 255 PSI	3	140 PSI		
Spindown Delay (ECU Off)	Sets the amount of time to keep the ECU off during a start attempt.	0 - 255 sec.	4	15		
Stabilize ECU (Powerup)	Sets the amount of time to allow the ECU or other controls to stabilize after power-up or coming out of standby.	0 - 60 sec.	4	5		

Parameter	Description	Range/Options	Minimum Required Security Level	Factory Default Setting	Applications Requiring This Setting	Customer Notes								
<b>SYSTEM CONTROL PARAMETERS</b>														
Start/Stop Type	Defines which type of input is used for start and stop during Automatic operations mode. (Note: For single switch, set up a digital input.)	2-switch, Level, Flow, Pressure	3	2-switch	2-switch Level Flow Pressure									
Switch Type	Defines type of switch used for 2-switch operation	Momentary	2	Momentary	2-switch									
Direction	Tied directly to Start/Stop Type.	<table border="1"> <thead> <tr> <th>Start/Stop Type</th> <th>Options</th> </tr> </thead> <tbody> <tr> <td>2-switch Level</td> <td>Empty, Fill, Maintain In, Maintain Out</td> </tr> <tr> <td>Flow</td> <td>Maintain In, Maintain Out</td> </tr> <tr> <td>Pressure</td> <td>Maintain In, Maintain Out</td> </tr> </tbody> </table>	Start/Stop Type	Options	2-switch Level	Empty, Fill, Maintain In, Maintain Out	Flow	Maintain In, Maintain Out	Pressure	Maintain In, Maintain Out	3	Empty	2-switch Level Flow Pressure	
Start/Stop Type	Options													
2-switch Level	Empty, Fill, Maintain In, Maintain Out													
Flow	Maintain In, Maintain Out													
Pressure	Maintain In, Maintain Out													
Maintain Sensitivity	Numeric value that controls how fast throttle responds. (Note: Only for when Direction is set as Maintain In or Maintain Out.)	1 - 100	3	4	Level Flow Pressure									

### System Control Parameter Diagrams

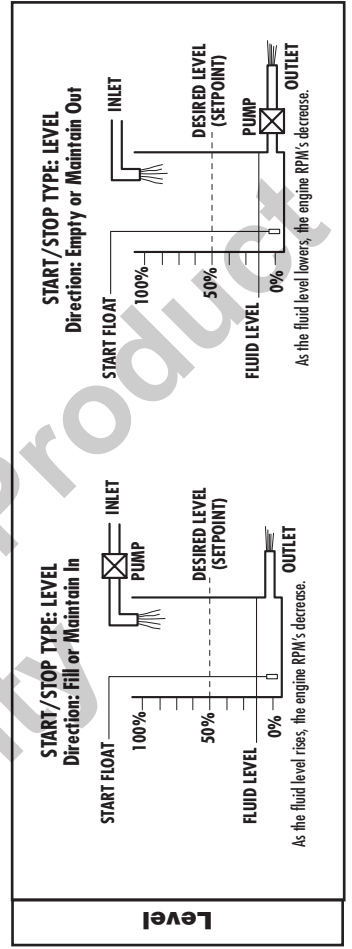
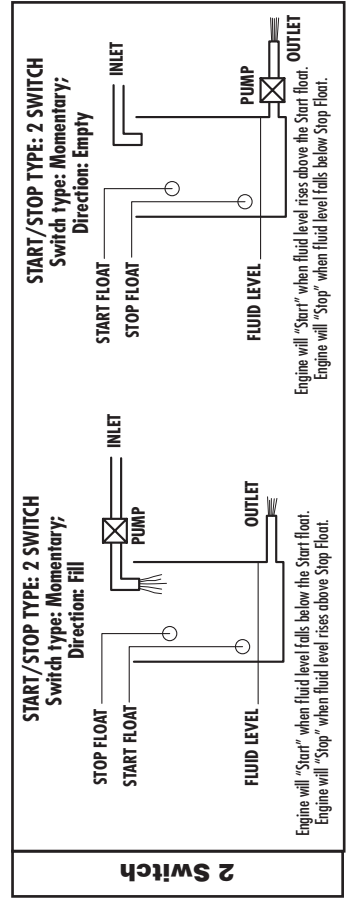
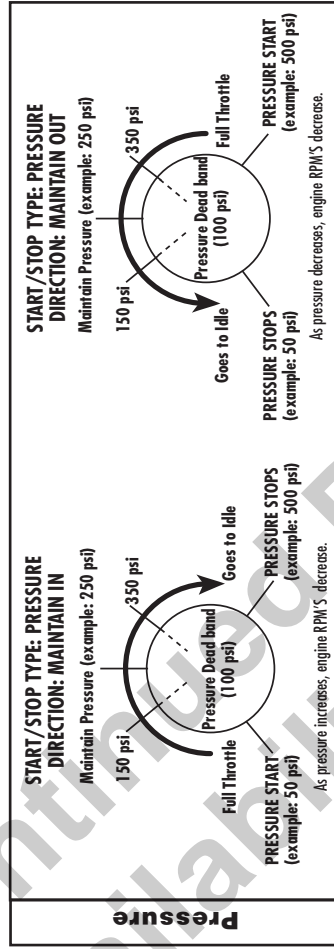
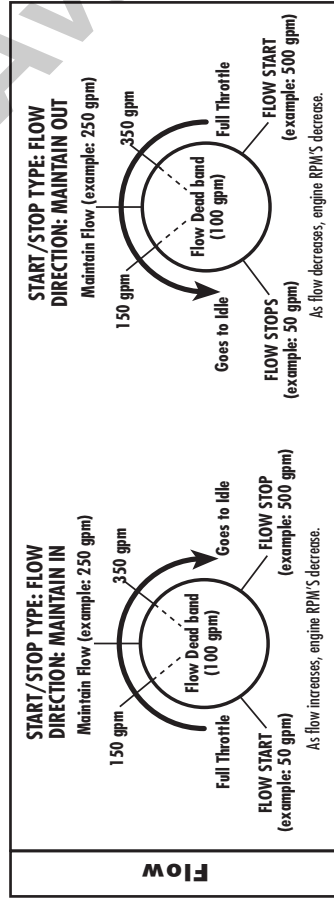

Parameter	Description	Range/Options	Minimum Required Security Level	Factory Default Setting	Applications Requiring This Setting	Customer Notes
<b>(The following parameters are active only when LEVEL is selected as the Start/Stop Type)</b>						
Level Start Speed	RPM at which the equipment will start in Auto when the Start Level is reached.	0 – 6000 RPM	3	2000 RPM	Level	
Level Stop Speed	RPM at which the equipment will stop in Auto when the Stop Level is reached.	0 – 6000 RPM	3	900 RPM	Level	
Start Level	Level where the engine will start. (Note: Tied to Direction: Empty, Fill, Maintain In or Maintain Out.)	0 – 255 ft.	3	5 ft.	Level	
Stop Level	Level where the engine will stop. (Note: Tied to Direction: Empty, Fill, Maintain In or Maintain Out.)	0 – 265 ft.	3	15 ft.	Level	
Maintain Level	This set-point will cause the controller to vary its throttle/RPM to maintain this level. (Note: For adjustment only. Applies to Direction: Maintain In or Maintain Out.)	0 – 255 ft.	3	10 ft.	Level	
Level Deadband	This setting defines the distance above or below the Maintain Level setting where no throttle changes will occur.	0.0 – 150.0 ft.	3	2.0 ft	Level	
<b>(The following parameters are active only when FLOW is selected as the Start/Stop Type)</b>						
Flow Start	This is the setting to cause the engine to start in AUTO mode.	0 – 25000 GPM	3	5000 GPM	Flow	
Flow Stop	This is the setting to cause the engine to stop in AUTO mode.	0 – 25000 GPM	3	10000 GPM	Flow	
Maintain Flow	This setpoint will cause the controller to vary its throttle/RPM to maintain this flow rate.	0 – 25000 GPM	3	7500 GPM	Flow	
Flow Deadband	Minimum GPM change that will cause the throttle to change.	0 – 25000 GPM	3	100 GPM	Flow	
Minimum Flow	This is the minimum RPM allowed by the controller while using the flow setup. If the flow actuates the setpoint while at this RPM, the controller will shut down and wait for the next start cycle.	0 – 6000 RPM	3	900 RPM	Flow	
Maximum Flow	This is the maximum RPM allowed by the controller while using the flow setup. If the flow actuates the setpoint while at this RPM, the controller will shut down and wait for the next start cycle.	0 – 6000 RPM	3	2000 RPM	Flow	

Parameter	Description	Range/Options	Minimum Required Security Level	Factory Default Setting	Applications Requiring This Setting	Customer Notes
<b>(The following parameters are active only when PRESSURE is selected as the Start/Stop Type)</b>						
Pressure Start	Pressure at which the equipment will start in Auto.	0 – 3000 PSI	3	250 PSI	Pressure	
Pressure Stop	Pressure at which the equipment will stop in Auto.	0 – 3000 PSI	3	750 PSI	Pressure	
Maintain Pressure	This set-point will cause the controller to vary its throttle/RPM to maintain this pressure.	0 – 3000 PSI	3	500 PSI	Pressure	
Pressure Deadband	This setting defines the distance above or below the Maintain Pressure setting where no throttle changes will occur.	0 – 500 PSI	3	50 PSI	Pressure	
Minimum RPM during Press.	The minimum RPM that the engine will run during Auto when Start/Stop Type is Pressure.	0 – 6000 RPM	3	900 RPM	Pressure	
Maximum RPM during Press. The maximum	RPM that the engine will run during Auto when Start/Stop Type is Pressure.	0 – 6000 RPM	3	2000 RPM	Pressure	
Low Suction Press. Warn.	(Note: Requires analog sensor to be installed on inlet side of pump.) Setting at which a warning will occur. (Note: Using this feature will prevent pump cavitation if inlet tube is obstructed.)	-100 – 3000 PSI	3	25 PSI	Pressure	
Low Suction Press. SD	(Note: Requires analog sensor to be installed on inlet side of pump.) Setting at which a shut-down will occur. (Note: Using this feature will prevent pump cavitation if inlet tube is obstructed.)	-1000 – 3000 PSI	3	10 PSI	Pressure	
Static Maintain Time	(Note: Coordinate with Static Maintain Speed.) This setting is the amount of time the engine will drive the pump at minimum or maximum RPM before it will shutdown. (Note: Used to avoid overheating a pump when flow becomes stagnant.)	Disabled, 1 sec. – 1 hour (Format 0:00:00)	3	Disabled	Pressure	
Static Maintain Count	Number of times that the engine will restart after a static maintain shut-down.	Disabled, 1 – 25	3	Disabled	Pressure	
Static Maintain Speed	Selects either minimum or maximum RPM.	Min. RPM, Max. RPM		Min. RPM	Pressure	

Parameter	Description	Range/Options	Minimum Required Security Level	Factory Default Setting	Applications Requiring This Setting	Customer Notes
<b>DIGITAL INPUT PARAMETERS</b>						
Digital Input 1	<p>Allows user to assign features listed in Range/Option column to any given digital input.</p> <p>Digital inputs have two possible values – either Normally Open (N/O) or Normally Closed (N/C).</p>	Remote Call to Run Remote Alarm Ack Engine Over Speed Crank Termination Low Fuel Level Fuel Leak Fuel Filter Restriction Air Damper Closed Air Filter Restriction Low Lube Oil Level Battery Charger Fail Low Coolant Level Emergency Stop N/O Emergency Stop N/C Oil Filter Restriction User Defined 1 User Defined 2 User Defined 3 User Defined 4 User Defined 5 User Defined 6 User Defined 7 User Defined 8 User Defined 9 User Defined 10 User Defined 11 User Defined 12 User Defined 13 User Defined 14 User Defined 15 User Defined 16 User Defined 17 User Defined 18 User Defined 19 User Defined 20 User Defined 21 User Defined 22 User Defined 23 User Defined 24 Remote Manual/Auto Idle Engine Remote Up Key Remote Down Key Remote Left Key Remote Right Key Run to Destruct Override, Modbus Mode Change OK Auto Start Switch Auto Stop Switch Throttle Dec (Bump Down) Throttle Inc (Bump Up) Remote Run Enable Disable Keyboard High Switch N/O Low Switch N/C	3	Engine Over Speed		
Digital Input 2				Autostart Switch		
Digital Input 3				Autostop Switch		
Digital Input 4				Low Lube Oil Lube		
Digital Input 5				Low Coolant Level		
Digital Input 6				Throttle Decrease (Bump Down)		
Digital Input 7				Throttle Increase (Bump Up)		
Digital Input 8				Disabled		
Digital Input 9				Disabled		
Digital Input 10				Disabled		
Digital Input 11				Disabled		
Digital Input 12				Disabled		
Digital Input 13				Disabled		
Digital Input 14				Disabled		
Digital Input 15				Disabled		
Digital Input 16				Disabled		
Digital Input 17				Disabled		
Digital Input 18				Disabled		
Digital Input 19				Disabled		
Digital Input 20				Disabled		
Digital Input 21				Disabled		
Digital Input 22				Disabled		
Digital Input 23				Disabled		
Digital Input 24				Disabled		





Parameter	Description	Range/Options	Minimum Required Security Level	Factory Default Setting	Applications Requiring This Setting	Customer Notes
<b>ANALOG INPUT PARAMETERS</b>						
Analog Input 1	Allows user to assign features listed in Range/Option column to any given analog input.  Analog inputs are represented as continuously varying voltage or current rather than as discrete values.	Oil Pressure 4-20mA	3			
Analog Input 2		Oil Pressure 0-5V				
Analog Input 3		Engine Temperature 4-20mA				
Analog Input 4		Engine Temperature 0-5V				
Analog Input 5		Fuel Level/Pressure 4-20mA				
Analog Input 6		Fuel Level/Pressure 0-5V				
Analog Input 7		Oil Temperature 4-20mA				
		Oil Temperature 0-5V				
		Suction Pressure 4-20mA				
		Suction Pressure 0-5V				
		DC Current 0-5V				
		Sump Level 4-20mA				
		Flow Rate 4-20mA				
		Fluid Pressure 4-20 mA				
	Datcon Oil Pressure					
	Murphy Oil Pressure					
	VDO 7Bar Oil Pressure					
	VDO 5Bar Oil Pressure					
	Datcon Temperature,					
	Murphy Temperature					
	VDO-A Temperature					
	VDO-B Temperature					
	Murphy Pressure 0-100					
	Sender for Suction Pressure					
	Murphy Fuel					
	Datcon Fuel					
	VDO Fuel					
	Datcon Oil Temperature					
	Murphy Oil Temperature					
	VDO Oil Temperature					
<b>CLOCK START/STOP PARAMETERS</b>						
Start Timer 1	Automatic mode start and stop timers. Allows user to set the time of day of week that eGuard will start and stop in automatic mode.	Off, XX:XX AM/PM + Day of Week	2	Off		
Stop Timer 1			2			
Start Timer 2			2			
Stop Timer 2			2			
Start Timer 3			2			
Stop Timer 3			2			

EGUARD POWERUP, STOP & ERRORSTOP STATE DIAGRAM

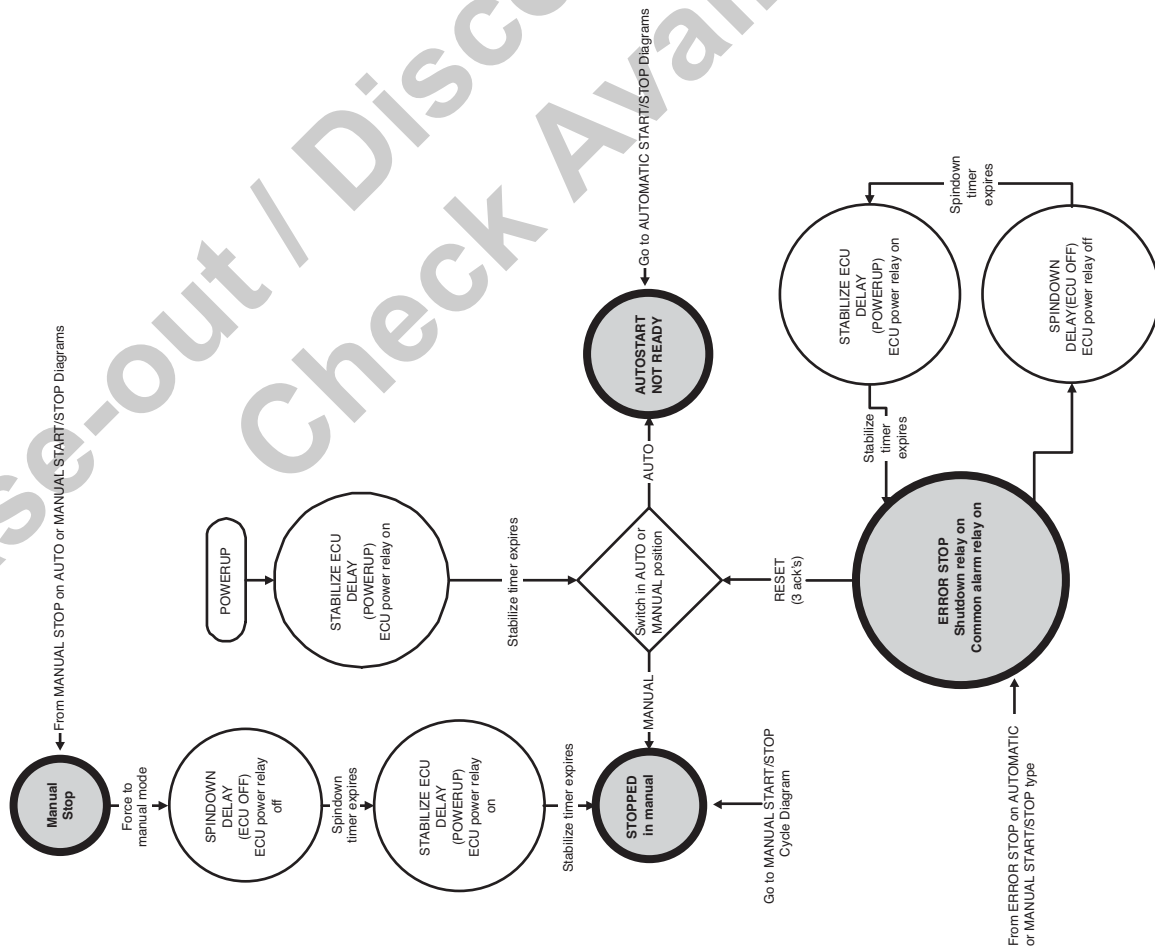

**Note:**  
 The circular shape represents a state. The name of the state appears in each circle along with some of the relay outputs for that state. The duration timer for each state is checked upon entry. If it is zero then that state is skipped.

Phase-out / Discontinued Product Check Availability



EGUARD MANUAL START/STOP STATE DIAGRAM

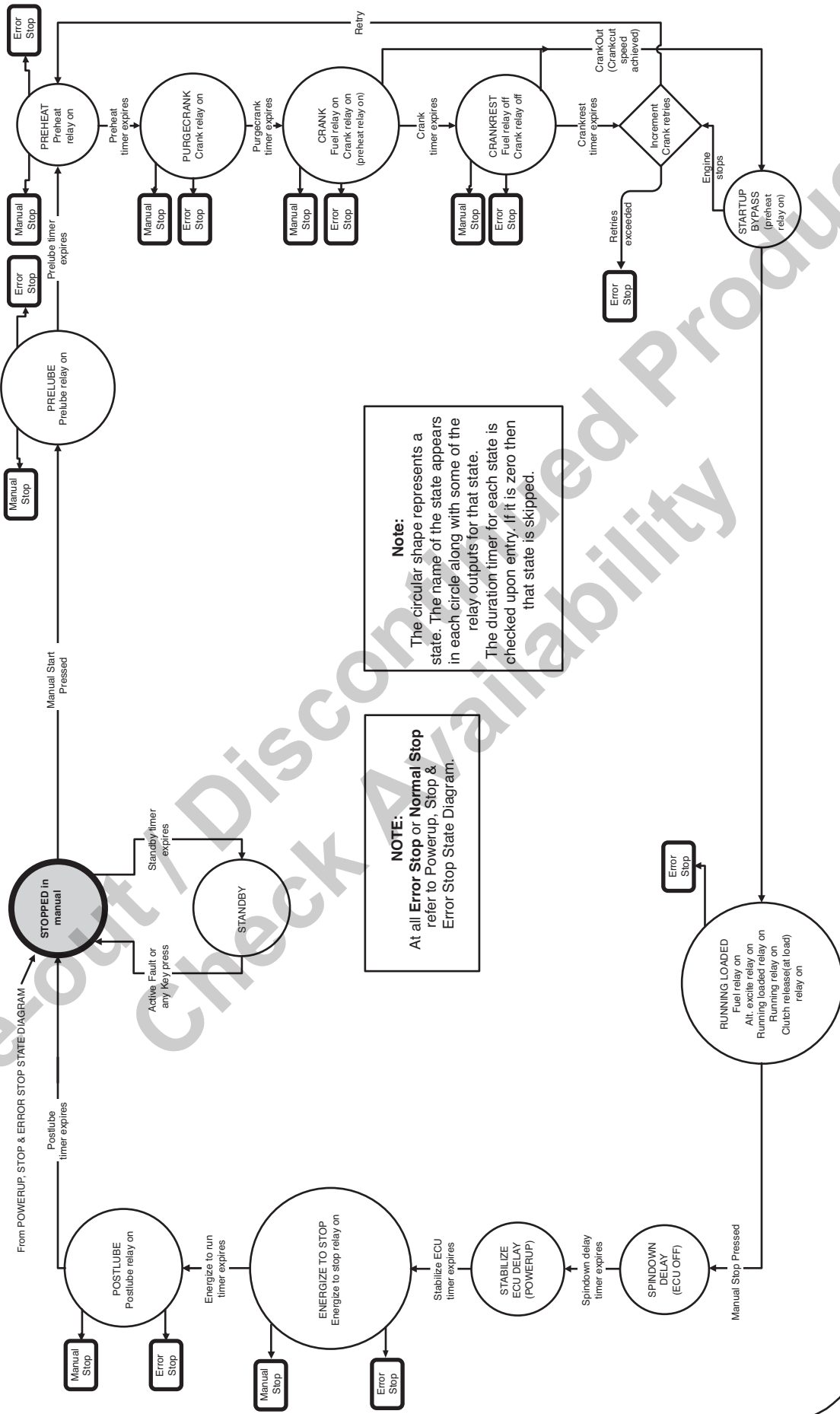

**Note:**  
The circular shape represents a state. The name of the state appears in each circle along with some of the relay outputs for that state. The duration timer for each state is checked upon entry, if it is zero then that state is skipped.

**NOTE:**  
At all Error Stop or Normal Stop refer to Powerup, Stop & Error Stop State Diagram.

## Finetuning

**Tip:** Prior to conducting the following finetuning adjustments, record current settings in the Parameter table, so that you can revert if necessary.

If engine short cranks or false starts, review the J1939 Crank Cut Count under Miscellaneous Parameters (the setting may need to be increased).

If engine holds cranking too long, review the J1939 Crank Cut Count under Miscellaneous Parameters (the setting may need to be decreased.)

If “ECU Not Responding” warning message displays after start-up, and you have Single selected under miscellaneous parameter ECU Address Claim, try changing the selection to None.

If engine is hunting or overshooting, review the following settings under Engine Parameters:

1. Decrease Throttle Deadband RPM.
2. Adjust Throttle Increase Pulse and/or Throttle Decrease Pulse.
3. Increase Throttle Feedback Delay.
4. As a last resort, adjust Throttle Sensitivity if desired finetuning cannot be reached through steps 1 – 3.

**NOTE:** If desired result is not achieved through sequence to left, revert to previous settings, and repeat steps in a different sequence (for example, begin with step 2.)

FOR TROUBLESHOOTING GUIDE, VISIT [WWW.FWMURPHY.COM](http://WWW.FWMURPHY.COM)

## Calibration of Senders for Analog Inputs

The 4-20mA or 0-5V sender you choose will have a defined scale range. For example, a 0-100 PSI 4-20mA pressure sender is supposed to measure 0mA when it is presented with 0 PSI and 20mA when it is presented with 100 PSI. The sender may vary 1 to 2 percent, unless it is calibrated. To calibrate:



- Go to the main Analog Input parameter menu screen.
- Select the physical channel (1-7) you want to assign to the 100 PSI sender.



- Press Enter to edit.



- Using the up and down keys, select the specific sender (for example, 4-20 mA fluid pressure sender). The current reading coming from the sender will be displayed in the top right area of the display. **(NOTE:** Ensure sender has no pressure applied.)

**NOTE:** It is critical that you select the proper input (see parameters table for full list of options.) For example, 13 pressure options are available. Selecting the wrong one will cause the controller to perform incorrectly.

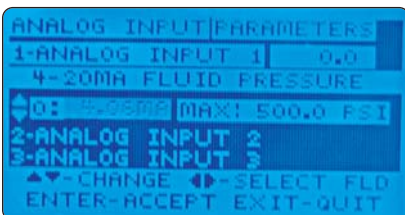

- Press the left arrow one time. Now the Zero Adjust should be flashing. (This adjusts the actual current in mA that the sender will output when 0 PSI is applied to it.)

## Finetuning *continued*

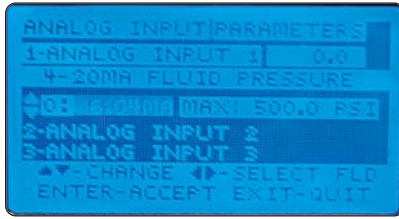

- Use the up and down keys to adjust the value in mA until the scaled value shows 0 PSI in the top right.



- Press the right arrow two times. Now the Max Adjust should be flashing. (This adjusts the actual scaled value in PSI that the sender should read at maximum range: 20mA.)

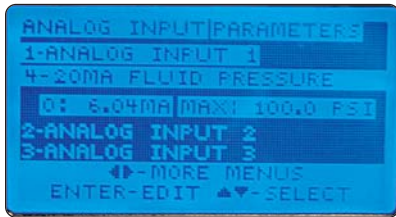

- Use the up and down keys to adjust the value in PSI until the scaled value shows 100 PSI in the top right.



- Press Enter to save the adjustment.

## Installation and Connections

### Standard Components

1. 24 digital inputs
2. 7 analog inputs
3. 1 magnetic pickup input
4. 8 20ssA form C relays
5. RS232 port
6. RS485 port
7. RS232/RS485 port
8. J1939 port
9. 64 x 128 pixel display with LCD backlight
10. 12-position keypad

### Physical Specifications

1. 3g, 3 axis, swept 10-1000Hz
2. Shipping dimensions: 10 x 9 in. (254 x 229 x 152 mm) approx.
3. Shipping weights: 2 lb. (910 g.) approx.
4. Mounting dimensions
5. 6.0 x 5.65 in. (152 mm x 144 mm)
6. 4 mounting screw holes, 0.200 in. diameter
7. 7.05 x 5.25 in. (179 mm x 13 mm) rectangular cutout
8. 2.76 in. (70 mm) wiring depth allowance

### Electrical Specifications

1. Supply voltage range: 8-35 VDC
2. Current: 90mA (Standby)
3. Current: 195mA (Running)
4. Low voltage signal inputs
5. Magnetic pickup input voltage range: 2V – 100 VRMS
6. Analog input voltage limits: 0-5 VDC

### The eGuard Controller Components

1. Bezel / Faceplate
2. "O" Ring
3. User Interface Board
4. I / O Board
5. Standoffs

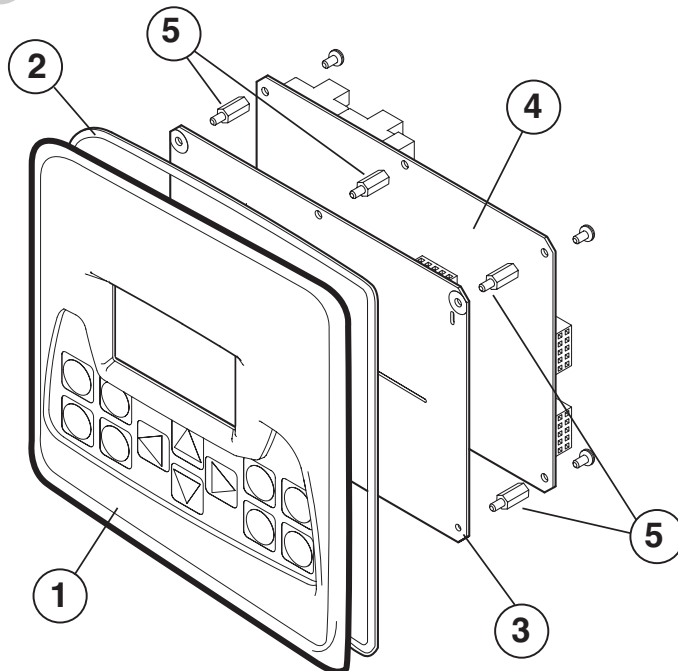

## Mechanical Installation and Mounting

### Before you begin installation

1. Verify that the eGuard was not damaged during shipping
2. Verify that all components are included
3. Verify that you have received all ordered accessories.
4. Plan the eGuard mounting for easy wiring access.

### eGuard Typical Mounting Schematic

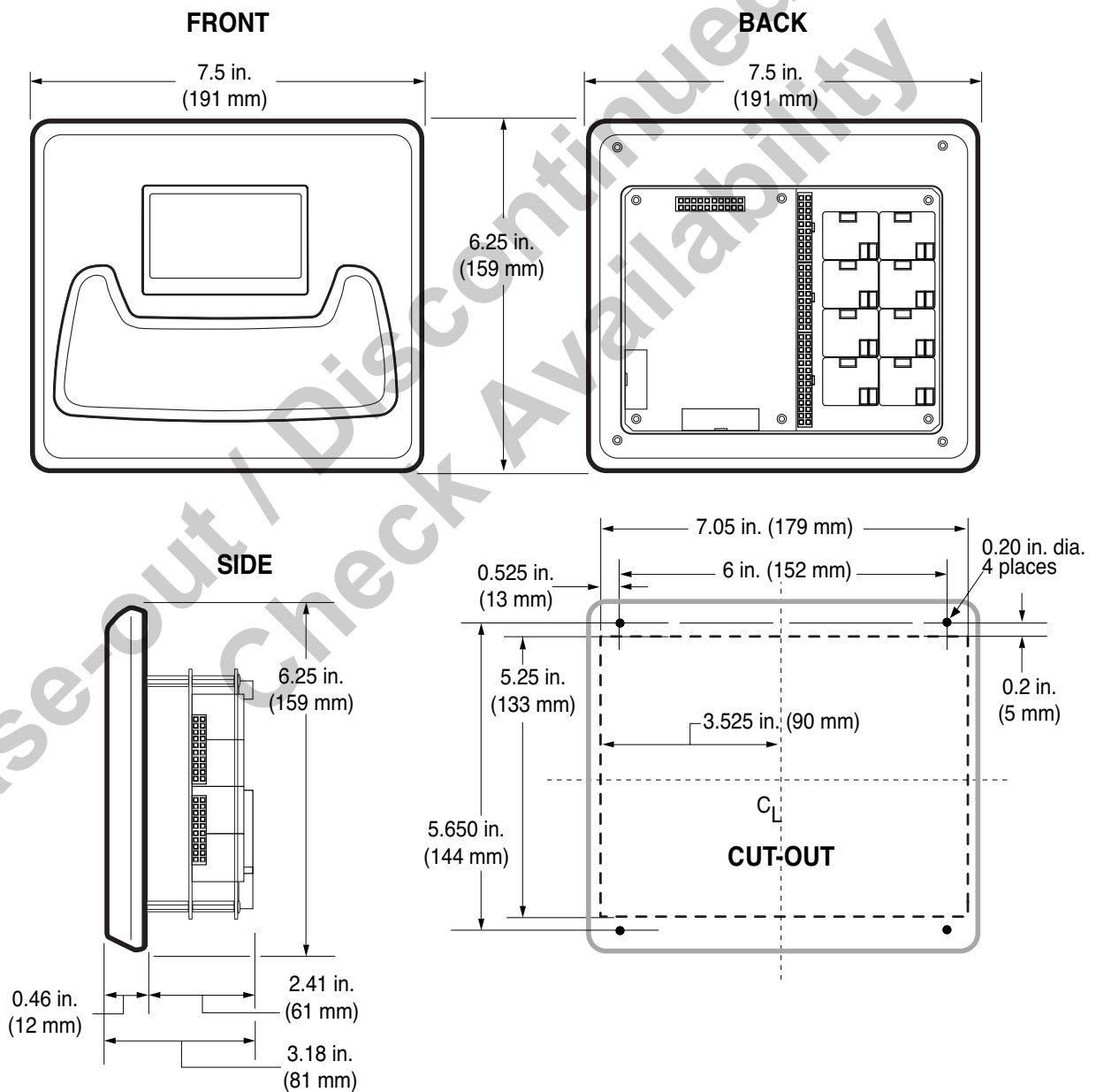

# eGuard Cutout Template

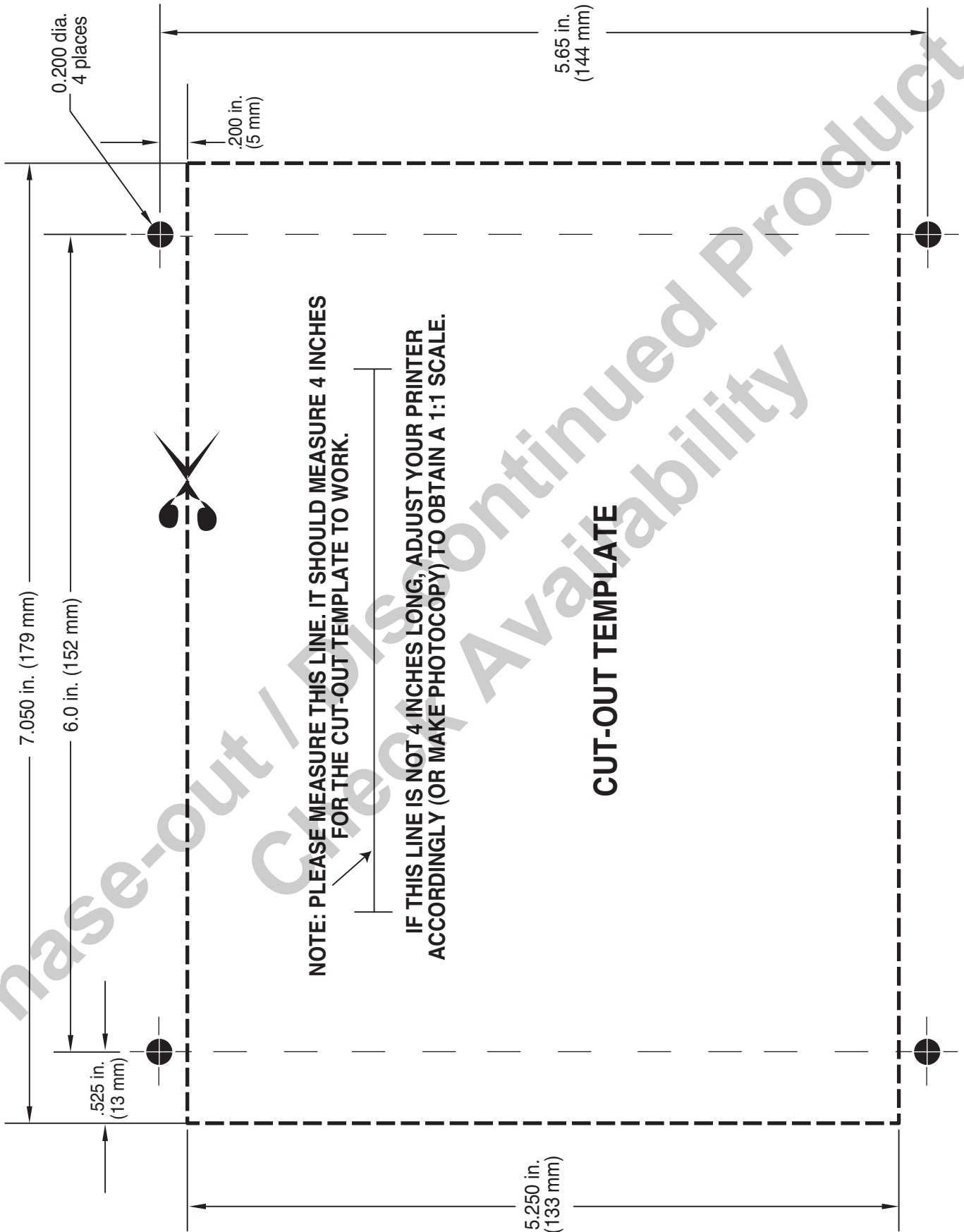

# eGuard Electrical Installation

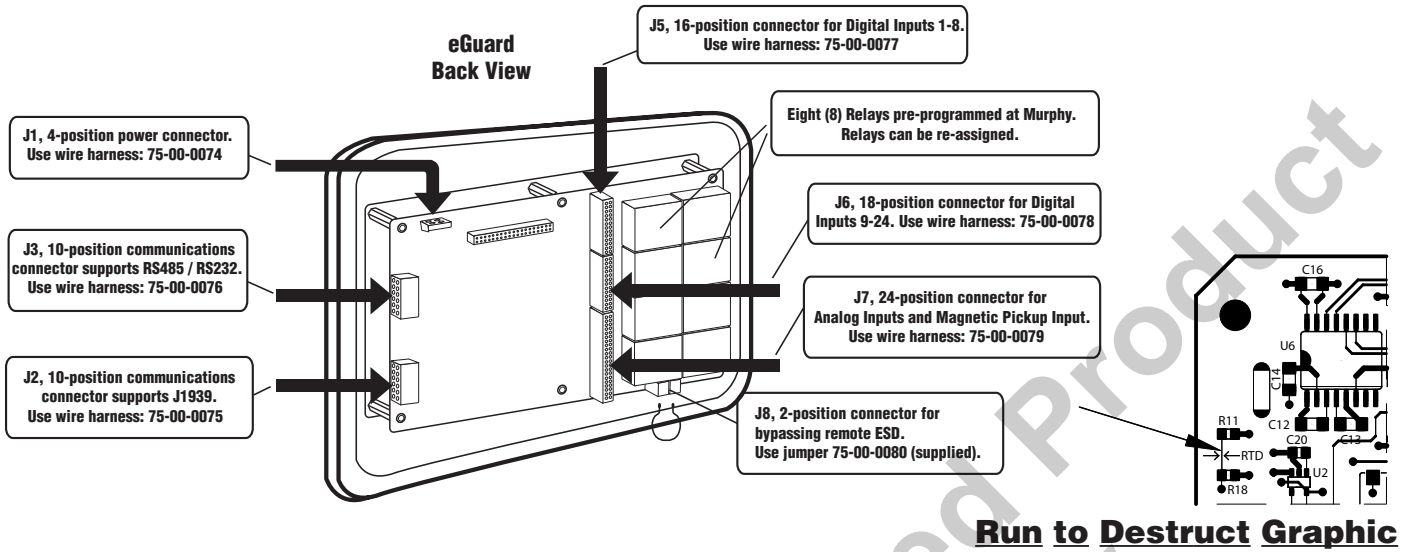

The eGuard is designed to operate from any DC supply from 8-35VDC continuous. It has a brownout ride through of 20 seconds (5V brownout), and a total blackout (0V) ride through of 100milliseconds. Environmentally, the controller is housed in a black, textured finish, UV stabilized polycarbonate injection molded housing, and comes with four #8-32 mounting screws and a rubber O-ring to seal out weather and insects from the front.

## Electrical Installation

There are several wire harnesses or wire harness plug-in connectors that may be shipped with the controller.

- **Two (2), 10-position connector:** for J1939, RS485 / RS232
- **One (1), 16-position connector:** for Digital Inputs
- **One (1), 18-position connector:** for Digital Inputs
- **One (1), 24-position connector:** for Analog Inputs
- **One (1), 4-position connector:** for DC supply

Additionally there is a 2-position connector for normally closed Emergency Shutdown switch that is shipped installed on the controller.

There are three (3), 1/4" blade type push on terminals for each of the eight (8) form "C" relays. They are Normally Open, Normally Closed, and Common. These contact outputs are dry.

The dual row white connectors are all intended for low voltage.

### J1 - Power connector

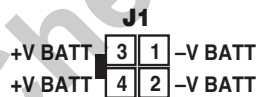

### J2 - Communications connector that supports J1939 and Modbus server (slave) communications

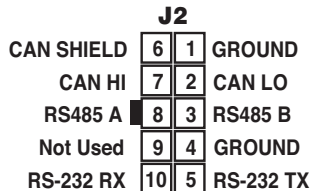

### J3 - Communications connector for RS-485 MODbus master output or RS232 communications with the iGCON configuring and updating software tool.

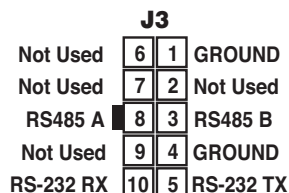

## eGuard Electrical Installation *continued*

- J5** - Digital inputs 1-8 Signals for the digital inputs 1-24 must be in the range of +V battery and ground. With the inputs wired as shown (this is the default), they will be active when there is a ground applied to the respective input.

<b>J5</b>			
DIGITAL INPUT 1-8 (TIE TO +V)	9	1	ENGINE OVERSPEED
	10	2	N.O. START FLOAT SWITCH
	11	3	N.O. STOP FLOAT SWITCH
	12	4	LOW LUBE OIL
	13	5	LOW COOLANT LEVEL
	14	6	THROTTLE INC (bump up)
	15	7	THROTTLE DEC (bump down)
	16	8	DISABLED

- J6** - Digital inputs 9-24.

<b>J6</b>			
TIE TO +V BATTERY	10	1	TIE TO +V BATTERY
DISABLED	11	2	DISABLED
DISABLED	12	3	DISABLED
DISABLED	13	4	DISABLED
DISABLED	14	5	DISABLED
DISABLED	15	6	DISABLED
DISABLED	16	7	DISABLED
DISABLED	17	8	DISABLED
DISABLED	18	9	DISABLED

- J7** - Connector for analog inputs and the magnetic pickup input.

The first 4 analog inputs have current sources for driving standard resistive senders. For best accuracy, and most noise immunity, senders should be of the two wire type, with the return wire coming back to the appropriate sender ground.

**NOTE:** Murphy recommends the use of two wire senders, with the sender return connected to the analog channel. If single ended senders are used, with ground provided at the sender itself, there can be a number of problems that may or may not affect any given installation. Since the sender provides sender ground, the use of insulating type thread tapes and compounds may give erratic operation. Additionally, the grounds may not be common and there always exists a greatly increased chance for noise and interference to affect the controller operation.

<b>J7</b>			
Analog 1- (ground)	13	1	Analog 1 + sender or 0-5VDC
Analog 2 + sender or 0-5VDC 250 load resistor for analog 2, jumper to J7-14 for 4-20mA	14	2	250 load resistor for analog 1, jumper to J7-1 for 4-20mA
Analog 3- (ground)	15	3	Analog 2- (ground)
Analog 4 + sender or 0-5VDC 250 load resistor for analog 4, jumper to J7-17 for 4-20mA	16	4	Analog 3 + sender or 0-5VDC
Analog 5- (ground)	17	5	250 load resistor for analog 3, jumper to J7-4 for 4-20mA
Analog 6 + or 0-5VDC 250 load resistor for analog 6, jumper to J7-20 for 4-20mA	18	6	Analog 4- (ground)
Analog 7- (ground)	19	7	Analog 5 + or 0-5VDC
Magnetic Pickup (+)	20	8	250 load resistor for analog 5, jumper to J7-7 for 4-20mA
Magnetic Pickup Shield (ground)	21	9	Analog 6- (ground)
	22	10	Analog 7 + or 0-5VDC
	23	11	250 load resistor for analog 7, jumper to J7-10 for 4-20mA
	24	12	Magnetic Pickup Shield (ground)

If your application uses the engine data supplied by the J1939 databus, there may be no connections to J7.

## eGuard Electrical Installation *continued*

**J8** - is the positive emergency stop. From the factory there is a loop from terminal 1 to terminal 2. **The controller will power up, but will not operate the relays without this jumper.** If your application requires a true positive emergency stop, we recommend that you install a normally closed type switch between terminals 1 & 2. In the event of an emergency stop, actuating the switch will remove power to the relays which will then return to their un-powered state.

**J8**  
 NC EMERGENCY SHUTDOWN OUT 2 1 N/C EMERGENCY SHUTDOWN IN

The 8 relays mounted on the I/O board are pre-programmed at the factory to:

<b>PREHEAT</b> <div style="border: 1px solid black; padding: 2px; margin: 2px;">COM</div> <div style="border: 1px solid black; padding: 2px; margin: 2px;">NO NC</div> RELAY 1	<b>ALT EXCITE</b> <div style="border: 1px solid black; padding: 2px; margin: 2px;">COM</div> <div style="border: 1px solid black; padding: 2px; margin: 2px;">NO NC</div> RELAY 2
<b>CRANK</b> <div style="border: 1px solid black; padding: 2px; margin: 2px;">COM</div> <div style="border: 1px solid black; padding: 2px; margin: 2px;">NO NC</div> RELAY 3	<b>ECU ENABLE</b> <div style="border: 1px solid black; padding: 2px; margin: 2px;">COM</div> <div style="border: 1px solid black; padding: 2px; margin: 2px;">NO NC</div> RELAY 4
<b>THROTT DEC</b> <div style="border: 1px solid black; padding: 2px; margin: 2px;">COM</div> <div style="border: 1px solid black; padding: 2px; margin: 2px;">NO NC</div> RELAY 5	<b>THROTT INC</b> <div style="border: 1px solid black; padding: 2px; margin: 2px;">COM</div> <div style="border: 1px solid black; padding: 2px; margin: 2px;">NO NC</div> RELAY 6
<b>COM. ALARM</b> <div style="border: 1px solid black; padding: 2px; margin: 2px;">COM</div> <div style="border: 1px solid black; padding: 2px; margin: 2px;">NO NC</div> RELAY 7	<b>NOT USED</b> <div style="border: 1px solid black; padding: 2px; margin: 2px;">COM</div> <div style="border: 1px solid black; padding: 2px; margin: 2px;">NO NC</div> RELAY 8

Relays may be re-assigned to any other desired functions from the front panel.

### Commercially Available Connectors

Connections to the eGuard are via Molex connectors, MiniFit Jr. (for white/opaque white signal level connectors), and Sabre series (for black EMB AC voltage and current connectors). 12 foot long harnesses are available from Murphy (see "Options and Accessories" section). If you elect to build your own wire harnesses the following manufacturers part numbers will be of use:

### Connector Part Numbers

The MiniFit Jr. series of connectors requires a crimping tool (such as a universal crimper) to properly terminate the connectors. When terminating multiple wire harnesses, contact your local Molex distributor for information on automated termination tooling. An extractor tool might also be necessary in case of a broken wire, mis-inserted terminal, or when a wire needs to be removed.

Plug - Low voltage signals	Molex Part Number - plug	Molex 16 ga. crimp on terminal	Molex 18-24 ga. crimp on terminal	Digikey Part Number - plug	Digikey 16 ga. crimp on terminal	Digikey 18-24 ga. crimp on terminal	Murphy PN Plug
2 conductor	39-01-2020	39-00-0078	39-00-0039	WM3700-ND	WM1913-ND	WM2501-ND	00009457
4 conductor	39-01-2040	39-00-0078	39-00-0039	WM3701-ND	WM1913-ND	WM2501-ND	00009458
10 conductor	39-01-2100	39-00-0078	39-00-0039	WM3704-ND	WM1913-ND	WM2501-ND	00009459
16 conductor	39-01-2160	39-00-0078	39-00-0039	WM3707-ND	WM1913-ND	WM2501-ND	00009460
18 conductor	39-01-2180	39-00-0078	39-00-0039	WM3708-ND	WM1913-ND	WM2501-ND	00009461
24 conductor	39-01-2240	39-00-0078	39-00-0039	WM3711-ND	WM1913-ND	WM2501-ND	00009462

<b>DigiKey Part Number</b>	WM9999-ND
<b>Manufacturer Part Number</b>	63811-1000
<b>Description</b>	Molex Universal Crimp Tool

<b>DigiKey Part Number</b>	WM9918-ND
<b>Manufacturer Part Number</b>	11-03-0044
<b>Description</b>	Extraction Tool Mini-Fit Jr.

<b>DigiKey Part Number</b>	WM9912-ND
<b>Manufacturer Part Number</b>	11-01-0197
<b>Description</b>	Crimp Tool 18-24 AWG Mini-Fit Jr.

*Molex and Digikey are registered trademarks of their respective corporations.*



#### FW Murphy

P.O. Box 470248  
 Tulsa, Oklahoma 74147 USA  
 +1 918 317 4100 **fax** +1 918 317 4266  
**e-mail** sales@fwmurphy.com

[www.fwmurphy.com](http://www.fwmurphy.com)

#### INDUSTRIAL PANEL DIVISION

P.O. Box 470248  
 Tulsa, Oklahoma 74147 USA  
 +1 918 317 4100 **fax** +1 918 317 4266  
**e-mail** sales@fwmurphy.com

#### MURPHY DE MEXICO, S.A. DE C.V.

Blvd. Antonio Rocha Cordero 300, Fracción del Aguaje  
 San Luis Potosí, S.L.P.; México 78384  
 +52 444 8206264 **fax** +52 444 8206336  
 Villahermosa Office +52 993 3162117  
**e-mail** ventas@murphymex.com.mx  
[www.murphymex.com.mx](http://www.murphymex.com.mx)

#### FRANK W. MURPHY, LTD.

Church Rd.; Laverstock, Salisbury SP1 1QZ; U.K.  
 +44 1722 410055 **fax** +44 1722 410088  
**e-mail** sales@fwmurphy.co.uk  
[www.fwmurphy.co.uk](http://www.fwmurphy.co.uk)



Printed in U.S.A.

*In order to consistently bring you the highest quality, full featured products, we reserve the right to change our specifications and designs at any time.*